

Data Sheet

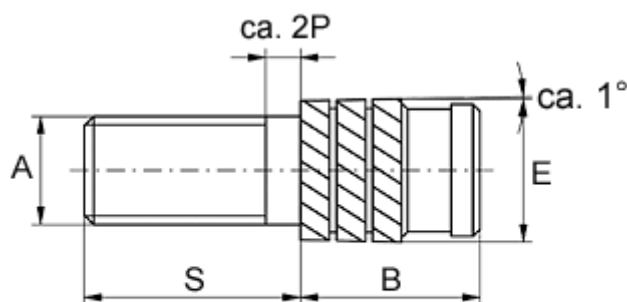

Article number: 12856000060860
Description: KLEE-coil 856 000 060.860
M6 Brass

Measures



Gevindlængde = $S - 2P$
P = stigning

Male thread A	= M6x1
Min distance to edge	= 2.8
Mounting length B	= 9.2
Outer diameter E	= 8.20
Pin length S	= 16
Recommended bore diameter	= 7.8
Type	= 856 000 060.860